

# **Wireless Miniature Circuit Breaker with Power Meter**

## **RP02RH Series Data Sheet**

**Copyright©Netvox Technology Co., Ltd.**

This document contains proprietary technical information which is the property of NETVOX Technology and is issued in strict confidential and shall not be disclosed to others parties in whole or in parts without written permission of NETVOX Technology. The specifications are subjected to change without prior notice

---

## Wireless Miniature Circuit Breaker with Power Meter

---

### Introduction

**RP02RH series** is a class C smart Miniature Circuit Breaker based on LoRaWAN open protocol. It can monitor the status of all external circuit breakers in real time (connect up to 9 poles).

When the wire is abnormal, such as undervoltage, overvoltage, overload, leakage, etc., the system will automatically warn, alarm, and power off. It can also periodically detect the temperature, energy, current, voltage, power, leakage current, circuit breaker status, etc. of all external short circuit breakers. The detected data will be reported to the gateway. With the system, it can be controlled remotely and regularly. It can be timing switched and automatically perform monthly leakage self-check, power limit, and electricity limit. It has the self-check function and reports the detected information to the gateway.

It can be switched to serial port transparent transmission mode which supports replying to up to 128 bytes of data (depending on the communication rate). The serial port transparent transmission only supports the RS-485 protocol.

Wireless Miniature Circuit Breaker with Power Meter



LoRa / LoRaWAN Radio Module



**RP02RH1PN063**

Wireless 1P+N Miniature Circuit Breaker with Power Meter, 63A



**RP02RH1PNLB063**

Wireless 1P+N Miniature Circuit Breaker with Power Meter and Leak Detection, 63A with 30mA sensitivity



**RP02RH3PN063**

Wireless 3P+N Miniature Circuit Breaker with Power Meter, 63A



**RP02RH3PNLB063**

Wireless 3P+N Miniature Circuit Breaker with Power Meter and Leak Detection, 63A with 30mA sensitivity

Wireless Miniature Circuit Breaker with Power Meter



**RP02RH2P100**

Wireless 2P Miniature Circuit Breaker with Power Meter, 100A



**RP02RH4P100**

Wireless 4P Miniature Circuit Breaker with Power Meter, 100A



**RP02RH3P250**

Wireless 3P Miniature Circuit Breaker with Power Meter, 250A

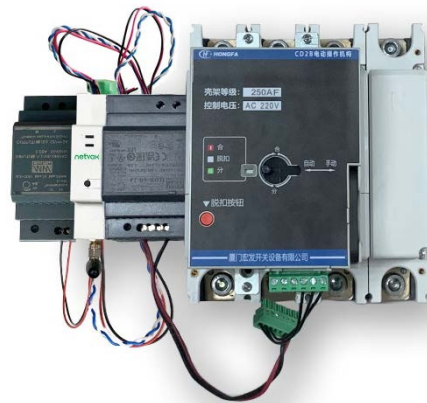

**RP02RH4P250**

Wireless 4P Miniature Circuit Breaker with Power Meter, 250A

Wireless Miniature Circuit Breaker with Power Meter

Features

- SX1276 wireless communication module
- RS485 communication
- LoRaWAN™ Class C compatible
- Frequency Hopping Spread Spectrum (FHSS)
- Applicable to third-party platforms: Actility/ThingPark, TTN, MyDevices/Cayenne

Applications

- School, shopping mall, supermarket, etc.
- Others

Dimensions

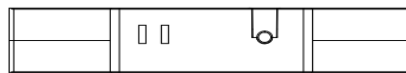
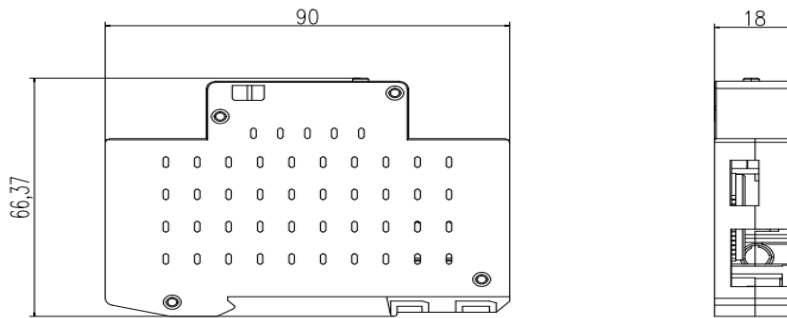

LoRa/LoRaWAN Radio Module

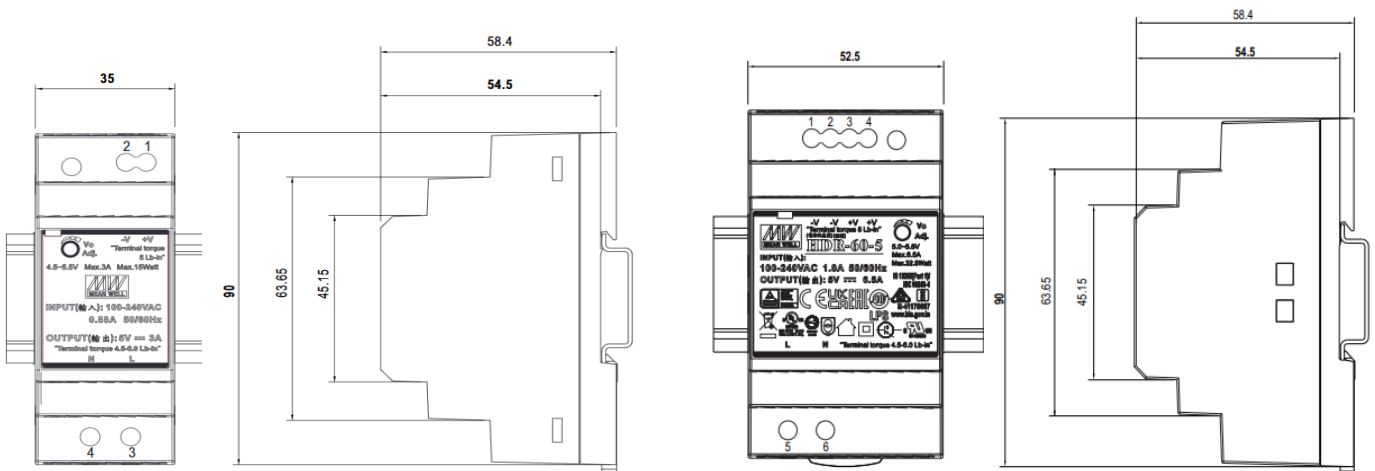

Power Module: HDR-30-12

Power Module: HDR-60-24

**Wireless Miniature Circuit Breaker with Power Meter**

**Electrical Specifications**

**LoRa/LoRaWAN Radio Module**

Power Supply	DC 12V
Operation Current	<100mA (when there is the RF signal transmission)

Note:

- (1) The electrical specifications may vary depending on the power supply voltage.
- (2) The output voltage of 12V provides power for LoRa/LoRaWAN Radio Module in the form of 4-pin terminal interface.

**Power Module - HDR-30-12**

(Provides power for LoRa/LoRaWAN Radio Module, 63A and 100A circuit breakers)

Model	HDR-30-12
Power Supply	AC100 – 240V
Output Voltage	12V ( Range: 10.8V – 13.8V )
Frequency	50Hz
Power	24W
Dimensions	35mm x 90mm x 54.5mm
Certification	UL, CB, CE, UKCA, TUV
Suggested Number of Circuit Breakers Supported by One Power Module	<p>The output power of the power module is 24W, and it supports connecting to 9 poles at most.</p> <p>1PN/1PNL/2P type circuit breaker has 2 poles.</p> <p>3P/3PN/3PNL/4P type circuit breaker has 4 poles.</p> <p>That is, one power module can carry four 1PNL type circuit breakers; one can carry two 3PNL type circuit breakers.</p>

---

**Wireless Miniature Circuit Breaker with Power Meter**

---

**Power Module - HDR-60-24**

(Provides power for 250A circuit breaker)

Model	HDR-60-24
Power Supply	AC 85 – 264V
Output Voltage	24V
Frequency	47 – 63Hz
Power	60W
Output Current	2.5A
Certification	UL, CB, CE, UKCA, TUV

Note: The motorized automatic switch of 250A circuit breaker requires 220V AC to operate.

**Frequency**

Frequency Range	863MHz-928MHz 470MHz-510MHz
TX Power	US915 20dbm AS923 16dbm AU915 20dbm CN470 19.15dbm EU868 16dbm KR920 14dbm IN865 20dbm
Receiving Sensitivity	-136 dBm (LoRa, Spreading Factor = 12, Bit Rate = 293bps) -121 dBm (FSK, Frequency deviation = 5kHz, Bit Rate = 1.2kbps)
Antenna Type	External rod antenna
Communication Distance	10 km (the actual transmission distance depends on the environment. )
Data Transfer Rate	0.3kbps – 50kbps (LoRaWAN) 1.2kbps – 300kbps (FSK)
Modulation Method	LoRa / FSK (Note: One modulation method is required.)
Supportable LoRaWAN Band	EU863-870, US902-928, AU915-928, KR920-923, AS923-1, AS923-2, AS923-3, IN865-867, CN470-510 (Note: optional, to be done in the factory configuration)

---

**Wireless Miniature Circuit Breaker with Power Meter**

---

**Physical**

Dimensions	Radio Module: L: 66.37 mm x W: 90 mm x H: 18 mm
Environment Temperature Range	-20°C – 55°C
Environment Humidity Range	<90% RH (No condensation)
Storage Temperature Range	-40°C – 85°C



Wireless Miniature Circuit Breaker with Power Meter

RP02RH1PN063

(HDR-30-12 Power Module + LoRa/LoRaWAN Radio Module + 63A 1PN Circuit Breaker)

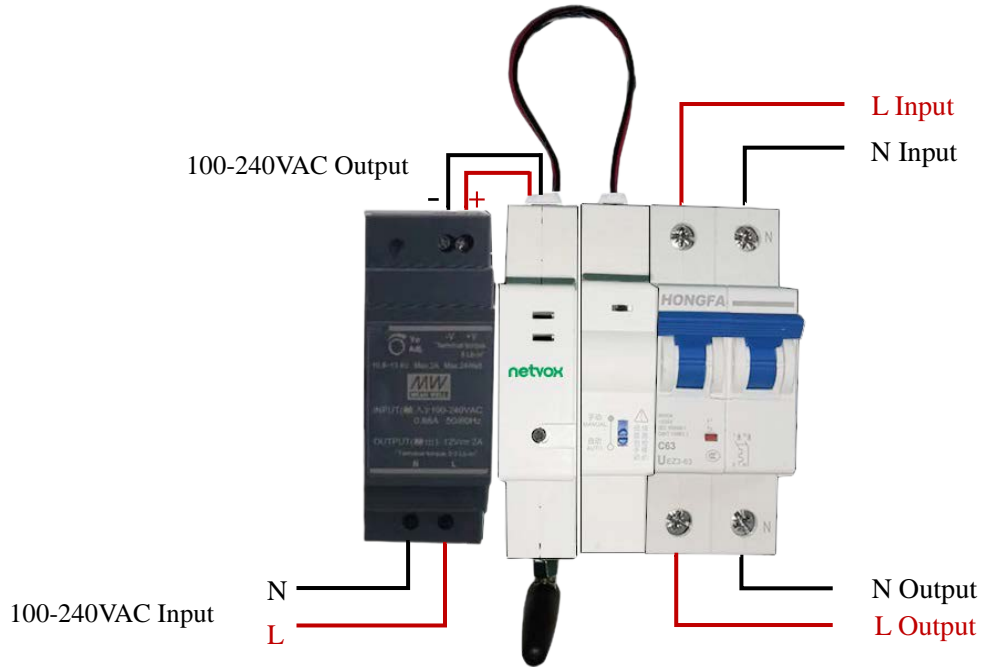

63A 1PN Circuit Breaker Parameter

<b>Rated Voltage</b>	AC230V / 50Hz
<b>Rated Current</b>	63A
<b>Breaking Capacity</b>	6kA
<b>Mechanical Life</b>	10,000 times
<b>Electrical Life</b>	6,000 times
<b>Communication Protocol</b>	RS485, Modbus-RTU
<b>Certified</b>	CB, CE, 3C, CQC
<b>Error Message</b>	10 messages
<b>Information Collection</b>	voltage, current, energy, power, frequency, temperature, and lifetime
<b>Accuracy</b>	voltage: $\pm 0.5\%$ ; current: $\pm 0.5\%$ ; energy: $\pm 1\%$ ; power: $\pm 1\%$
<b>Alarm</b>	overload, overvoltage, undervoltage, temperature, and overpower
<b>Protection</b>	short circuit protection, overload setting current protection, overvoltage protection, undervoltage protection, over-temperature protection, and overpower protection



Wireless Miniature Circuit Breaker with Power Meter

RP02RH1PNLB063

(HDR-30-12 Power Module + LoRa/LoRaWAN Radio Module + 63A 1PNL Circuit Breaker)

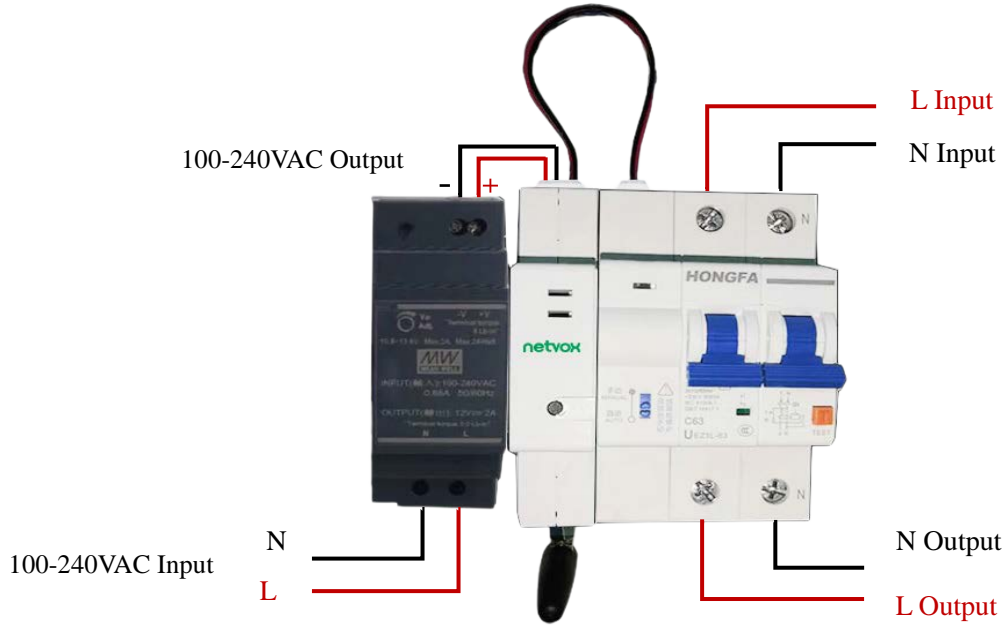

63A 1PNL Circuit Breaker Parameter

Rated Voltage	AC230V / 50Hz
Rated Current	63A
Breaking Capacity	6kA
Mechanical Life	10,000 times
Electrical Life	6,000 times
Communication Protocol	RS485, Modbus-RTU
Residual Current Type	AC type
Residual Current	30mA
Certified	CB, CE, 3C, CQC
Information Collection	leakage, voltage, current, energy, power, frequency, temperature, and lifetime
Accuracy	voltage: $\pm 0.5\%$ ; current: $\pm 0.5\%$ ; energy: $\pm 1\%$ ; power: $\pm 1\%$ leakage: $\pm 1\text{mA}$ (theoretical value)
Alarm	leakage, overload, overvoltage, undervoltage, temperature, and overpower
Protection	leakage protection, short circuit protection, overload setting current protection, overvoltage protection, undervoltage protection, over-temperature protection, and overpower protection



Wireless Miniature Circuit Breaker with Power Meter

RP02RH3PN063

(HDR-30-12 Power Module + LoRa/LoRaWAN Radio Module + 63A 3PN Circuit Breaker)

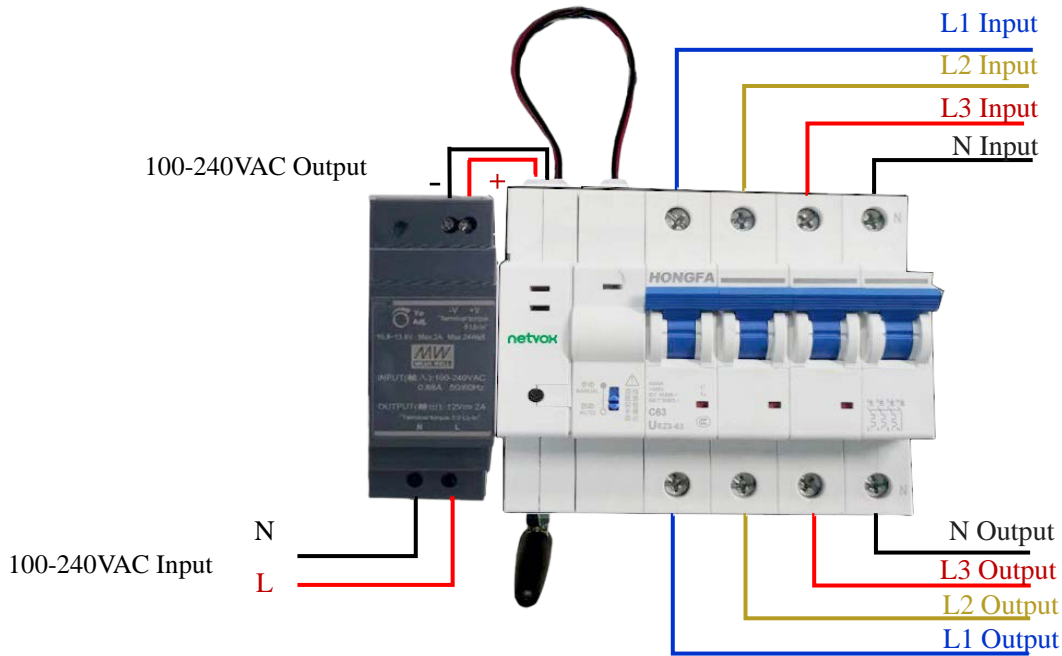

63A 3PN Circuit Breaker Parameter

<b>Rated Voltage</b>	AC400V / 50Hz
<b>Rated Current</b>	63A
<b>Breaking Capacity</b>	6kA
<b>Mechanical Life</b>	10,000 times
<b>Electrical Life</b>	6,000 times
<b>Communication Protocol</b>	RS485, Modbus-RTU
<b>Certified</b>	CB, CE, 3C, CQC
<b>Error Message</b>	10 messages
<b>Information Collection</b>	voltage, current, energy, power, frequency, temperature, and lifetime
<b>Accuracy</b>	voltage: ±0.5%; current: ±0.5%; energy: ±1%; power: ±1%
<b>Alarm</b>	overload, overvoltage, undervoltage, temperature, and overpower
<b>Protection</b>	short circuit protection, overload setting current protection, overvoltage protection, undervoltage protection, over-temperature protection, and overpower protection



Wireless Miniature Circuit Breaker with Power Meter

RP02RH3PNLB063

(HDR-30-12 Power Module + LoRa/LoRaWAN Radio Module + 63A 3PNL Circuit Breaker)

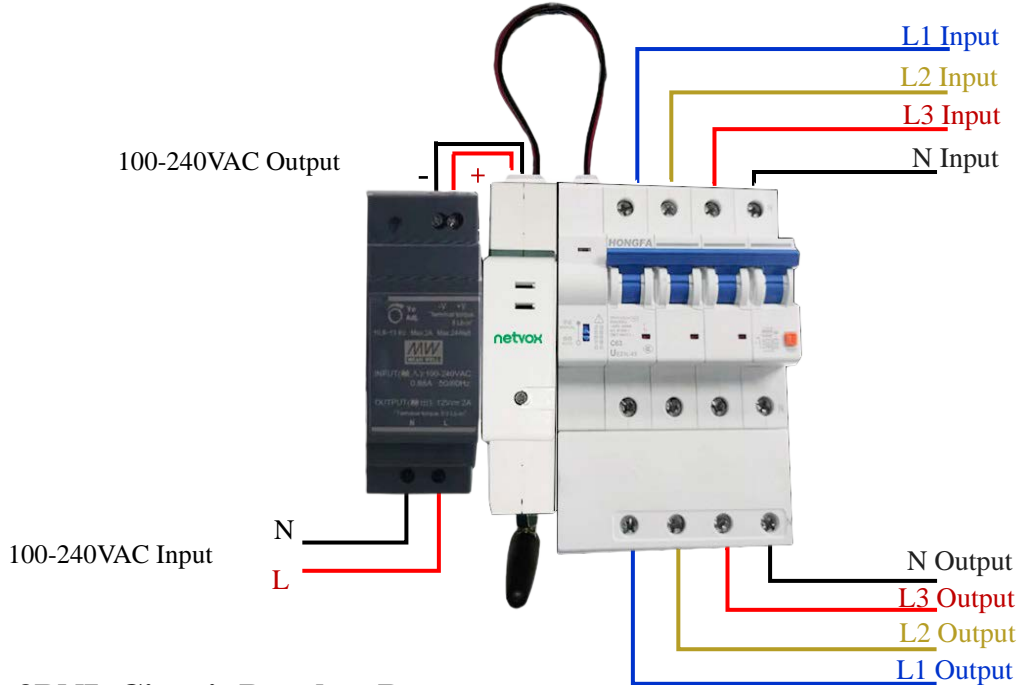

63A 3PNL Circuit Breaker Parameter

Rated Voltage	AC400V / 50Hz
Rated Current	63A
Breaking Capacity	6kA
Mechanical Life	10,000 times
Electrical Life	6,000 times
Communication Protocol	RS485, Modbus-RTU
Residual Current Type	AC type
Residual Current	30mA
Certified	CB, CE, 3C, CQC
Information Collection	leakage, voltage, current, energy, power, frequency, temperature, and lifetime
Accuracy	voltage: $\pm 0.5\%$ ; current: $\pm 0.5\%$ ; energy: $\pm 1\%$ ; power: $\pm 1\%$ leakage: $\pm 1\text{mA}$ (theoretical value)
Alarm	leakage, overload, overvoltage, undervoltage, temperature, and overpower
Protection	leakage protection, short circuit protection, overload setting current protection, overvoltage protection, undervoltage protection, over-temperature protection, and overpower protection



Wireless Miniature Circuit Breaker with Power Meter

RP02RH2P100

(HDR-30-12 Power Module + LoRa/LoRaWAN Radio Module + 100A 2P Circuit Breaker)

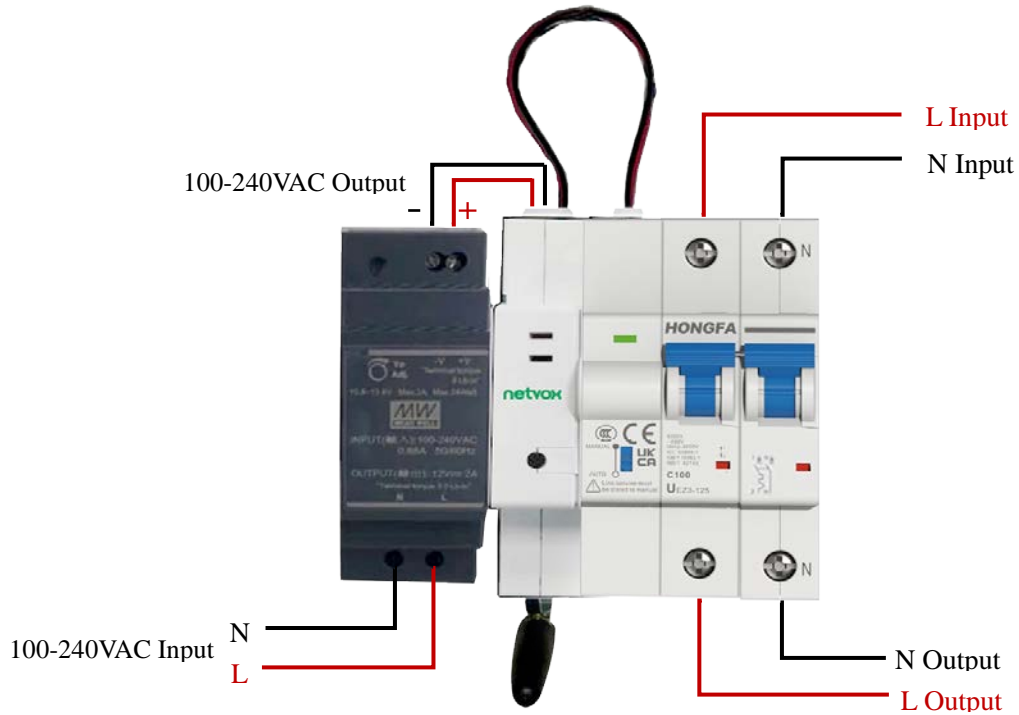

100A 2P Circuit Breaker Parameter

Rated Voltage	AC230V / 50Hz
Rated Current	100A
Breaking Capacity	6kA
Mechanical Life	10,000 times
Electrical Life	4,000 times
Communication Protocol	RS485, Modbus-RTU
Certified	CB, CE, 3C, UKCA
Error Message	10 messages
Information Collection	voltage, current, energy, power, frequency, and lifetime
Accuracy	voltage: ±1%; current: ±1%; energy: ±2%; power: ±2%
Alarm	overload, overvoltage, undervoltage, and overpower
Protection	short circuit protection, overload setting current protection, overvoltage protection, undervoltage protection, and overpower protection



Wireless Miniature Circuit Breaker with Power Meter

RP02RH4P100

(HDR-30-12 Power Module + LoRa/LoRaWAN Radio Module + 100A 4P Circuit Breaker)

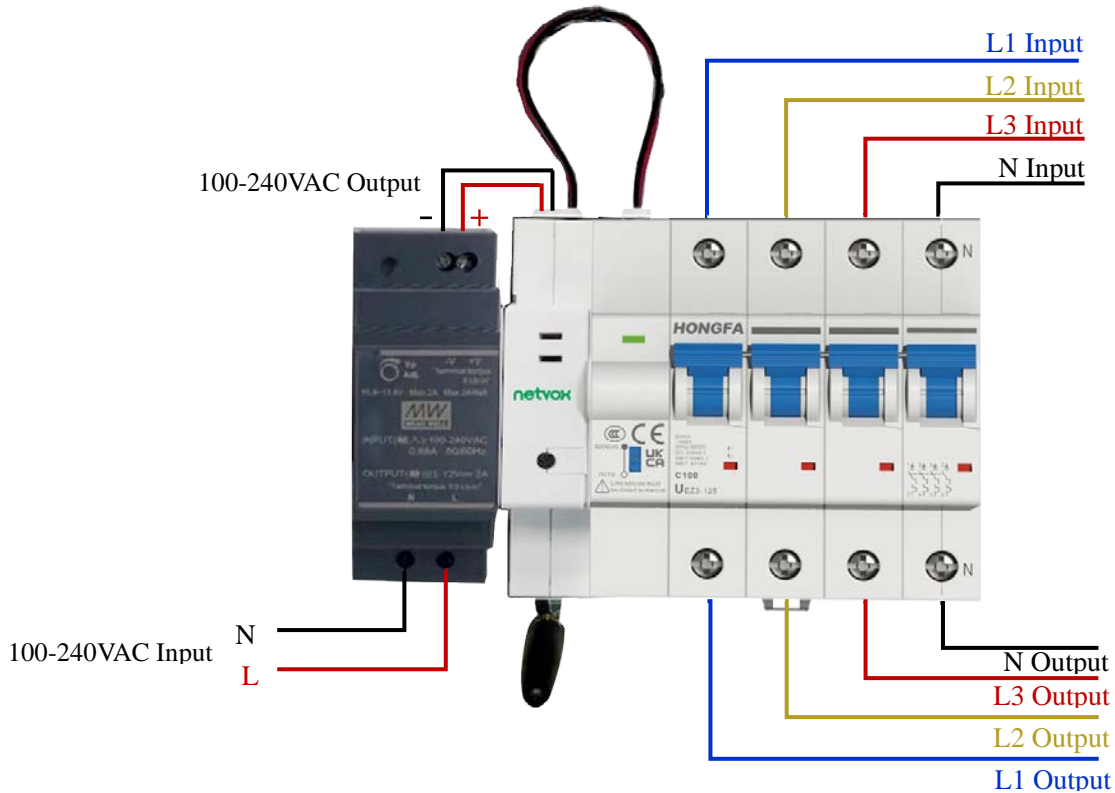

100A 4P Circuit Breaker Parameter

Rated Voltage	AC400V / 50Hz
Rated Current	100A
Breaking Capacity	6kA
Mechanical Life	10,000 times
Electrical Life	4,000 times
Communication Protocol	RS485, Modbus-RTU
Certified	CB, CE, 3C, UKCA
Error Message	10 messages
Information Collection	voltage, current, energy, power, frequency, and lifetime
Accuracy	voltage: $\pm 1\%$ ; current: $\pm 1\%$ ; energy: $\pm 2\%$ ; power: $\pm 2\%$
Alarm	overload, overvoltage, undervoltage, and overpower
Protection	short circuit protection, overload setting current protection, overvoltage protection, undervoltage protection, and overpower protection



Wireless Miniature Circuit Breaker with Power Meter

RP02RH3P250

( HDR-30-12 Power Module + LoRa/LoRaWAN Radio Module + HDR-60-24 Power Module + 250A 3P Circuit Breaker)

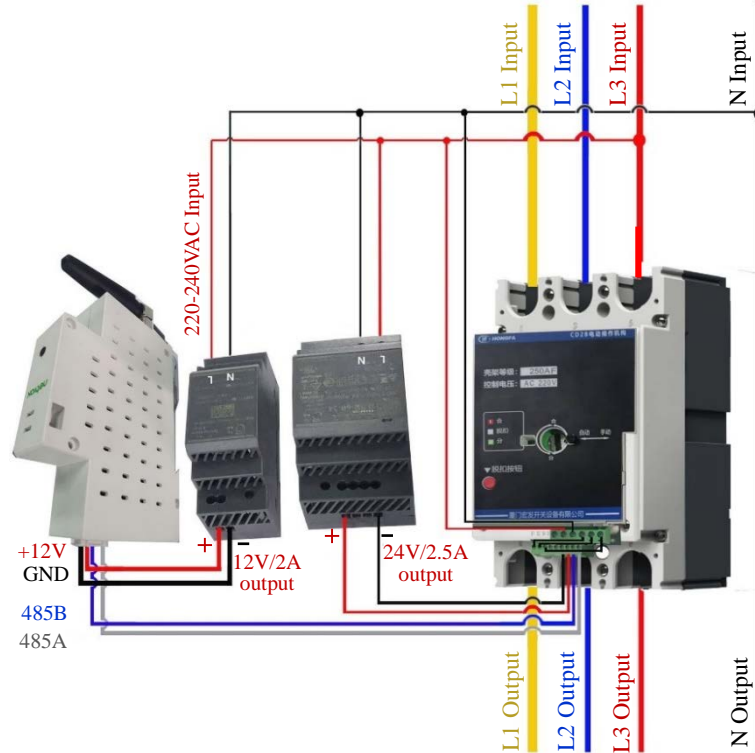

250A 3P Circuit Breaker Parameter

Rated Voltage	Circuit breaker:	AC400V / 50Hz	Motorized automatic switch:	AC220V / 50Hz	
Rated Current		250A			
Operating Capacity	Rated Breaking Capacity	25kA			
Maximum Operating Capacity	Rated Breaking Capacity	35kA			
Communication Protocol		RS485, Modbus-RTU			
Certified		CB, CE, 3C, UKCA			
Error Message		10 messages			
Information Collection		current, voltage, active power, reactive power, apparent power, frequency, energy, power factor, and terminal temperature			

**Wireless Miniature Circuit Breaker with Power Meter**

<b>Accuracy</b>	Phase voltage (20V – 80V): ±2%; (80V – 265V): ±1% Line voltage (34V – 138V): ±2%; (80V – 265V): ±1% Current (100A~300A): ±1%; Energy: ±2%; Power: ±2%
<b>Alarm</b>	long-time overload, short-time short circuit, overvoltage, undervoltage, terminal temperature, phase loss
<b>Protection</b>	neutral line protection, long-time overload protection, short-time short circuit protection, instantaneous short circuit protection, terminal temperature protection, overvoltage protection, undervoltage protection, and phase loss protection

Note:

When the rated current is in the range of 100A to 250A, users could change it to 100A, 125A, 140A, 160A, 180A, 200A, 225A, and 250A by CircuitBreakerConfigTool.

**RP02RH4P250**

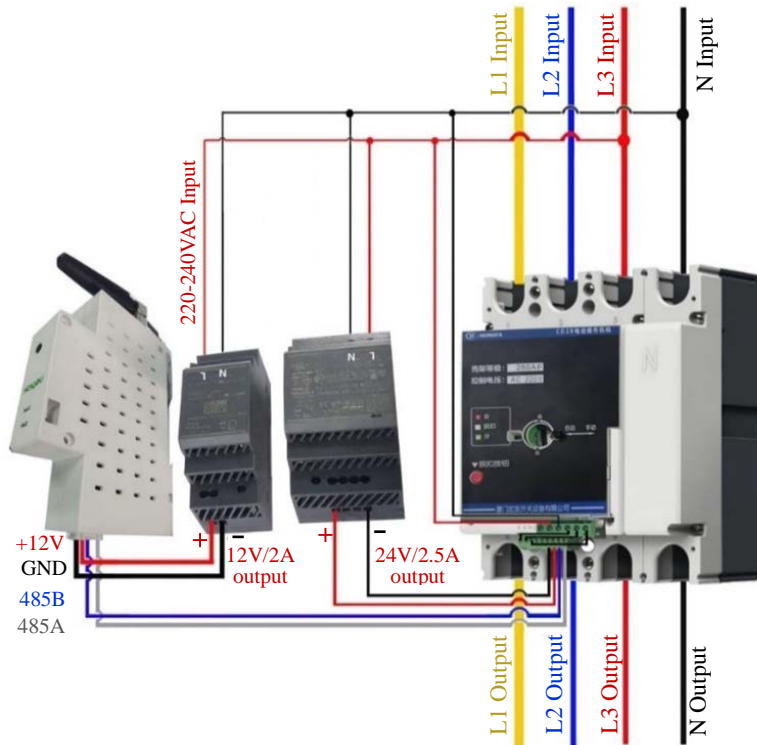

(HDR-30-12 Power Module + LoRa/LoRaWAN Radio Module + HDR-60-24 Power Module + 250A 4P Circuit Breaker)





**Wireless Miniature Circuit Breaker with Power Meter**

**250A 4P Circuit Breaker Parameter**

<b>Rated Voltage</b>	<u>Circuit breaker:</u> AC400V / 50Hz <u>Motorized automatic switch:</u> AC220V / 50Hz	Motorized automatic switch 
<b>Rated Current</b>	250A	
<b>Operating Rated Breaking Capacity</b>	25kA	
<b>Maximum Rated Breaking Capacity</b>	35kA	
<b>Communication Protocol</b>	RS485, Modbus-RTU	
<b>Certified</b>	CB, CE, 3C, UKCA	
<b>Error Message</b>	10 messages	
<b>Information Collection</b>	current, voltage, active power, reactive power, apparent power, frequency, energy, power factor, and terminal temperature	
<b>Accuracy</b>	Phase voltage (20V – 80V): ±2%; (80V – 265V): ±1% Line voltage (34V – 138V): ±2%; (80V – 265V): ±1% Current(100A~300A): ±1%; Energy: ±2%; Power: ±2%	
<b>Alarm</b>	long-time overload, short-time short circuit, overvoltage, undervoltage, terminal temperature, phase loss	
<b>Protection</b>	neutral line protection, long-time overload protection, short-time short circuit protection, instantaneous short circuit protection, terminal temperature protection, overvoltage protection, undervoltage protection, and phase loss protection	

Note:

When the rated current is in the range of 100A to 250A, users could change it to 100A, 125A, 140A, 160A, 180A, 200A, 225A, and 250A by CircuitBreakerConfigTool.