

Wireless Water Leak Detection and Location Sensor

RA07W User Manual

Copyright©Netvox Technology Co., Ltd.

This document contains proprietary technical information which is the property of NETVOX Technology. It shall be maintained in strict confidence and shall not be disclosed to other parties, in whole or in part, without written permission of NETVOX Technology. The specifications are subject to change without prior notice.

Table of Content

1.Introduction	2
2.Appearance	3
3.Main Feature.....	3
4.Application	3
5.Set Up Instruction.....	4
6.Data Report.....	5
7.Installation	8
8.Important Maintenance Instruction	10



1. Introduction

RA07W is a ClassA type device based on the LoRaWAN open protocol of Netvox and is compatible with the LoRaWAN protocol.

It is the long-distance wireless device for locating the leakage position.

LoRa Wireless Technology:

LoRa is a wireless communication technology dedicated to long distance and low power consumption. Compared with other communication methods, LoRa spread spectrum modulation method greatly increases to expand the communication distance.

Widely used in long-distance, low-data wireless communications. For example, automatic meter reading, building automation equipment, wireless security systems, industrial monitoring. Main features include small size, low power consumption, transmission distance, anti-interference ability and so on.

LoRaWAN:

LoRaWAN uses LoRa technology to define end-to-end standard specifications to ensure interoperability between devices and gateways from different manufacturers.

2. Appearance

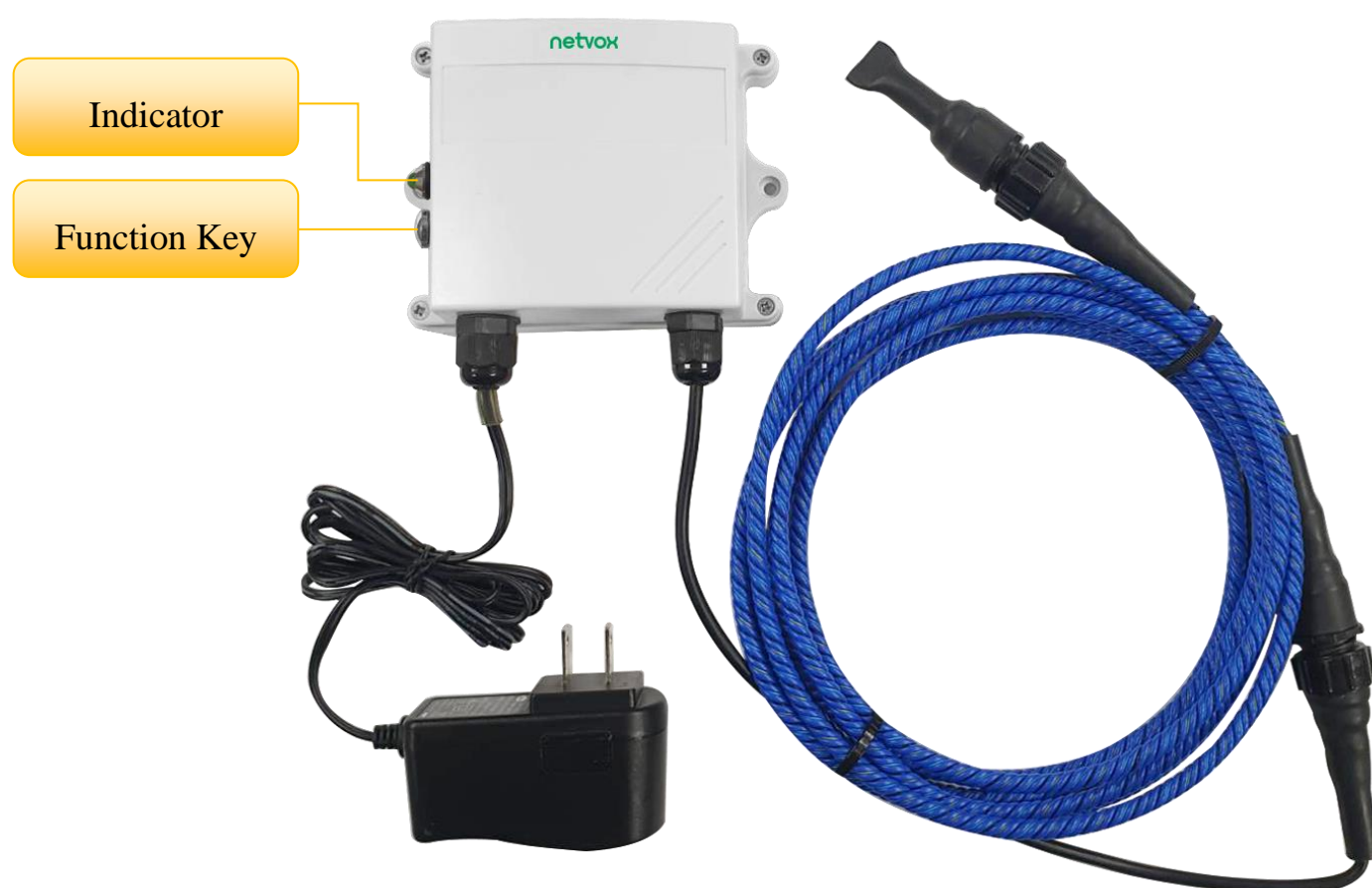

3. Main Feature

- Compatible with LoRaWAN
- Adopt SX1276 wireless communication module
- DC 12V adapter power supply
- Protection level: IP65
- Detect the water contact position of the leakage detection line
- Locate the leakage position
- Simple operation and setting

4. Application

- Data center and computer room
- Leakage monitoring in basement
- Water pipe leakage detection
- Ship bilge monitoring
- Archives
- Warehouse

Other occasions need to be detected whether there is the water leakage or are more sensitive to water leakage.

5. Set Up Instruction

On/Off

Power ON	RA07W are connected to DC 12V adapter for power on.
Turn On	Connect with power on to turn on.
Restore to Factory Setting	Press and hold the function key for 5 seconds and the green indicator flashes 20 times.
Power Off	Disconnect from the power supply.
Note	<ol style="list-style-type: none"> 1. Press and hold any button to power on, and the device will be in engineering test mode. 2. On/off interval is suggested to be about 10 seconds to avoid the interference of capacitor inductance and other energy storage components.

Network Joining

Never Join the Network	<p>Turn on the device to search the network.</p> <p>The green indicator keeps on for 5 seconds: success.</p> <p>The green indicator remains off: fail</p>
Had Joined the Network (Not in the factory setting)	<p>Turn on the device to search the previous network.</p> <p>The green indicator keeps on for 5 seconds: success.</p> <p>The green indicator remains off: fail.</p>
Fail to Join the Network	Suggest checking the device registration information on the gateway or consulting your platform server provider if the device fails to join the network.

Function Key

Press and Hold for 5 Seconds	<p>Restore to the factory setting / Turn off</p> <p>The green indicator flashes 20 times: success</p> <p>The green indicator remains off: fail</p>
Press once	<p>The device is in the network: the green indicator flashes once and the device sends a data report.</p> <p>The device is not in the network: the green indicator remains off.</p>

Restore to Factory Setting

Description	RA07W has the function of the power-down saving the memory of network-joining information. This function acquiesces in turn off, that is, it will rejoin every time when it is power on. If the device is turned on by the ResumeNetOnOff command, the last network-joining information will be recorded when every time it is power on. (including saving the network address information that it is assigned, etc.) If users want to join a new network, the device needs to perform the factory setting, and it will not rejoin the last network.
Operation Method	<ol style="list-style-type: none">1. Press and hold the binding button for 5 seconds and then release (release the binding button when the LED flashes), and the LED will flash 20 times.2. The device automatically restarts to rejoin the network.

6. Data Report

After power on, the device will immediately send a version packet report and a data report.

The device sends data according to the default configuration before any other configuring.

Default Setting:

MaxTime = 3600s

MinTime = 3600s

If there is no leakage, it will report once every 3600s.

If the leakage change is greater than 2dm, the leakage information will be reported immediately.

The reported data of the device is the situation of the liquid leakage.

Water Leak Detection:

(1) Before usage, the sensor length must be set through the instruction. (Unit: dm.)

(2) The accuracy of the device is expressed as \pm (Length of detection line*0.5%+0.5m).

(3) When the vertical surface of the leaking sensor is submerged by water, and the horizontal surface exceeds 5cm,

the device will detect the leaking state, locate the specific position of the leakage, and immediately report the data to the gateway.

*The current sampling cycle is 1s.

The positioning data may be deviated when just soaked in water, and then the value will stabilize after 5s.

The device reported data parsing please refer to *Netvox LoraWAN Application Command document* and *Netvox Lora Command*

Resolver <http://www.netvox.com.cn:8888/page/index>

Example of ConfigureCmd

FPort: 0x07

Bytes	1	1	Var (Fix =9 Bytes)
	CmdID	DeviceType	NetvoxPayLoadData

CmdID– 1 byte

DeviceType– 1 byte – Device Type of Device

NetvoxPayLoadData– var bytes (Max=9bytes)

Description	Device	Cmd ID	Device Type	NetvoxPayLoadData		
ConfigReport Req	RA07W	0x01	0x0C	MinTime (2bytes Unit: s)	MaxTime (2bytes Unit: s)	Reserved (5Bytes, Fixed 0x00)
ConfigReport Rsp		0x81		Status (0x00_success)	Reserved (8Bytes, Fixed 0x00)	
ReadConfig ReportReq		0x02		Reserved (9Bytes, Fixed 0x00)		
ReadConfig ReportRsp		0x82		MinTime (2bytes Unit: s)	MaxTime (2bytes Unit: s)	Reserved (5Bytes, Fixed 0x00)

(1) Configure RA07W device parameter MinTime = 3600s, MaxTime = 3600s

Downlink: 010C0E100E100000000000

Device returns:

810C00000000000000000000 (Configuration success)

810C01000000000000000000 (Configuration failure)

(2) Read RA07W device parameter

Downlink: 020C000000000000000000

Device return:

820C0E100E100000000000 (device current parameter)

Example of Configuring Sensor Parameter:

SetSensorPara Req	RA07W	0x03	0x0C	LineLength (2Bytes, Unit:10cm)	Sensitivity (1Byte,Hihg_0x00,Mid_0x01,Low_0x02)	Reserved (6Bytes,Fixed 0x00)		
SetSensorPara Rsp		0x83		Status (0x00_success)	Reserved (8Bytes, Fixed 0x00)			
GetSensorPara Req		0x04		Reserved (9Bytes, Fixed 0x00)				
GetSensorPara Rsp		0x84		LineLength (2Bytes, Unit:10cm)	Sensitivity (1Byte,Hihg_0x00,Mid_0x01,Low_0x02)	Reserved (6Bytes, Fixed 0x00)		

(1) Configure RA07W line length = 700cm, Sensitivity 00 // 700cm=70dm (decimeter)

Downlink: 030C00460000000000000000 // 46 H_{ex} =70 D_{ec}

Device returns:

830C00000000000000000000 (Configuration success)

830C01000000000000000000 (Configuration failure)

(2) Read RA07W device parameter

Downlink: 040C00000000000000000000

Device return:

840C00460000000000000000

7. Installation

1. RA07W is fixed with screws (purchased by self), and the device is fixed to the wall or other surface (as the figure below).

Note: Do not install the device in a metal shielded box or in an environment with other electrical equipment around it to avoid affecting the wireless transmission of the device.

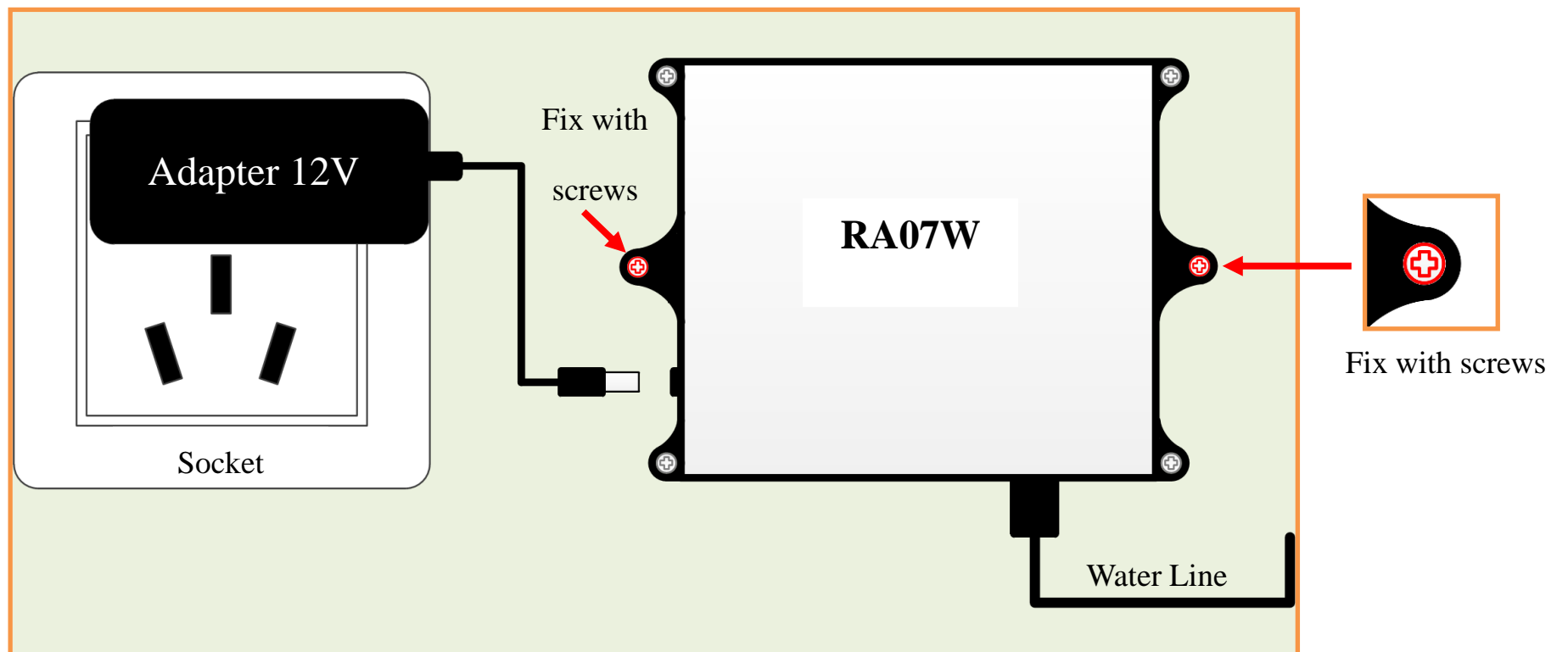

2. Water Line Structure

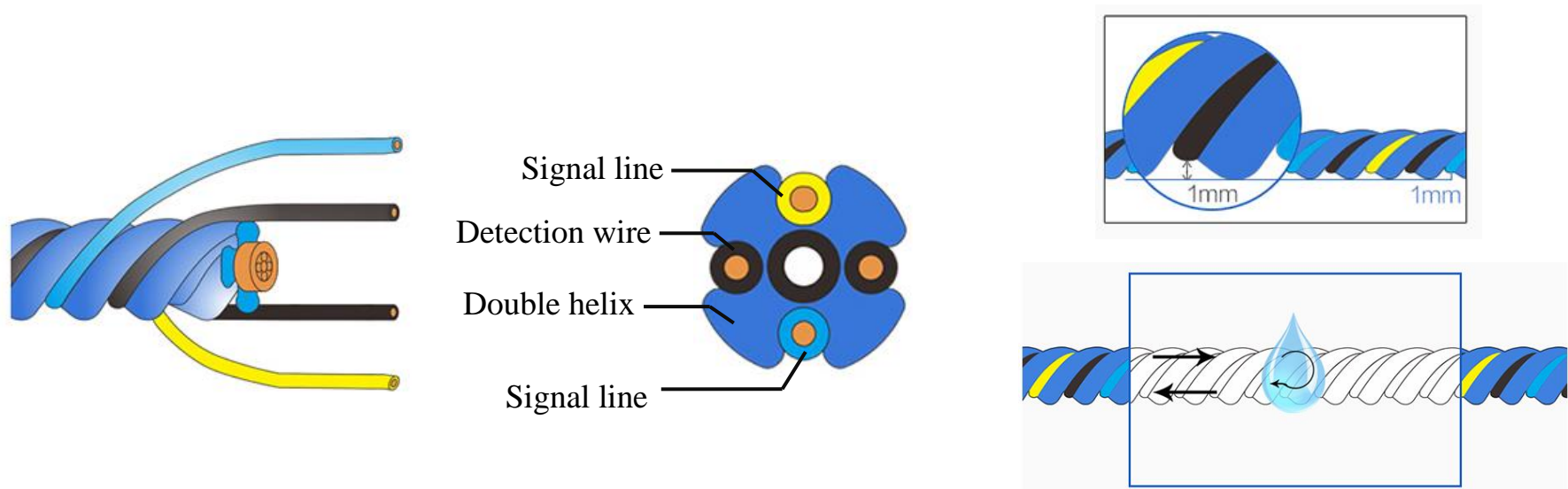

Length of Water Line: up to 100 meters

Water Detection Alarm: It is recommended that the length of the line is soaked in water greater than 5cm, and the depth of the line is greater than 2mm. (refer to the installation diagram)

Alarm time: immediately report (within 10 seconds)

*The length of the water line has been set via the main unit before shipping. If the rope need to be manually wired, the length of the line must be set via the main unit when it is used at the first time.

3. Installation Suggestions and Example



fixed by cable clips
(recommend)



fixed by vertical
(recommend)



hoisting along pipe
(recommend)



binding with metal
(susceptible to interference)



fixed by glue
(susceptible to damage cable)

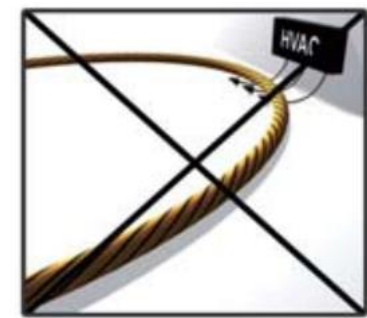

in front of air-conditioning outlet
(damp to false alarm)

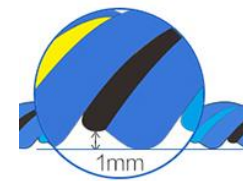
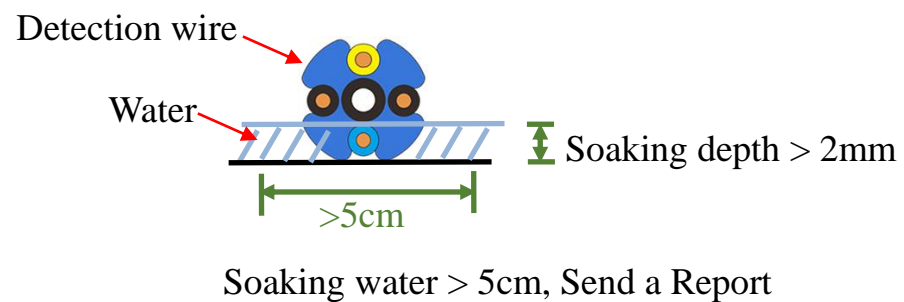
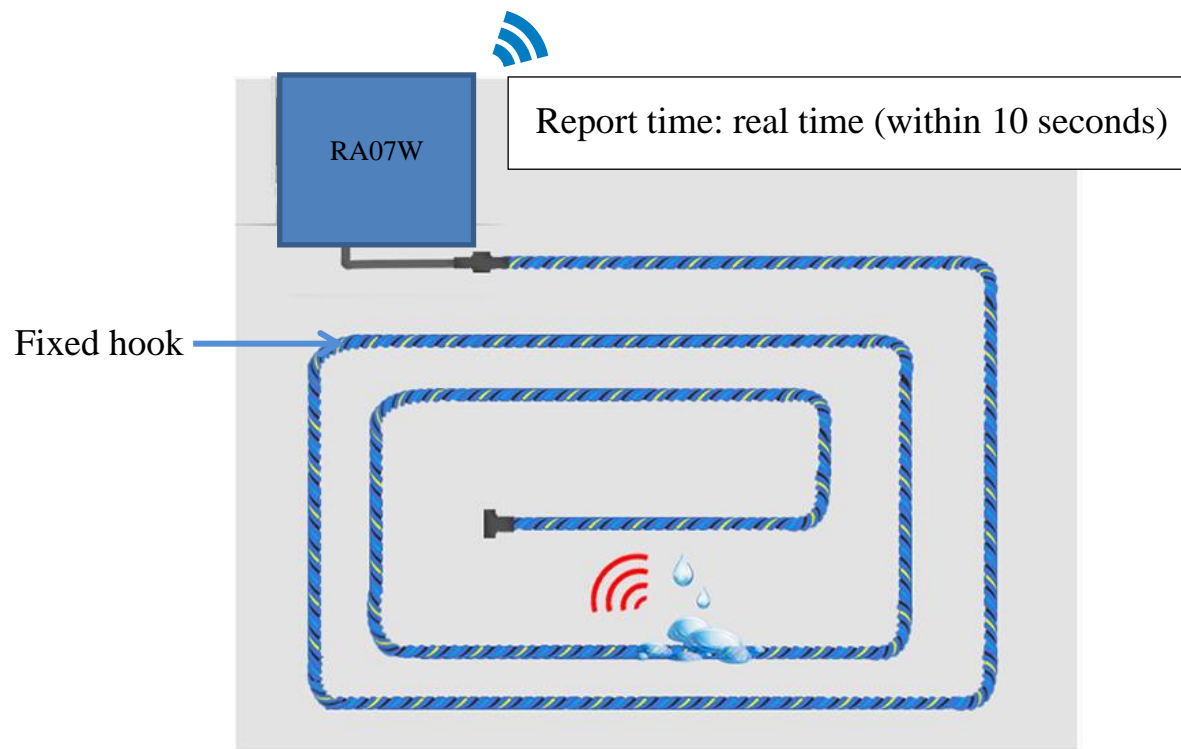

Note:

The installation position of the water line should be far away from high-temperature fire, strong magnetic fields, and humid and dusty environments. Take care to avoid all kinds of sharp objects from scratching the cable sheath.

8. Important Maintenance Instruction

The device is a product with superior design and craftsmanship and should be used with care.

The following suggestions will help you use the warranty service effectively.

- Keep the equipment dry. Rain, moisture and various liquids or water may contain minerals that can corrode electronic circuits.
In case the device is wet, please dry it completely.
- Do not use or store in dusty or dirty areas. This way can damage its detachable parts and electronic components.
- Do not store in excessive heat place. High temperatures can shorten the life of electronic devices, destroy batteries, and deform or melt some plastic parts.
- Do not store in excessive cold place. Otherwise, when the temperature rises to normal temperature, moisture will form inside which will destroy the board.
- Do not throw, knock, or shake the device. Treating equipment roughly can destroy internal circuit boards and delicate structures.
- Do not wash with strong chemicals, detergents, or strong detergents.
- Do not paint the device. Smudges can make debris block detachable parts up and affect normal operation.
- Do not throw the battery into the fire to prevent the battery from exploding. Damaged batteries may also explode.
- The average time that PM2.5 Dust Sensor is without any failures is 3 years. If the concentration is more than 300ug/m³ for more than 50% of a year, or the concentration exceeds 500ug/m³ for more than 20% of a year, the consistency of the sensor will decrease. The data may be high because of the internal dust accumulation.

All the above suggestions apply equally to your device, batteries, and accessories.

If any device is not operating properly.

Please take it to the nearest authorized service facility for repairing.