

Wireless Single-Phase Current Meter

R718N1xxx(E) Series User Manual

Copyright©Netvox Technology Co., Ltd.

This document contains proprietary technical information which is the property of NETVOX Technology. It shall be maintained in strict confidence and shall not be disclosed to other parties, in whole or in part, without written permission of NETVOX Technology. The specifications are subject to change without prior notice.

Table of Contents

1. Introduction.....	2
2. Appearance.....	3
3. Features.....	5
4. Set up Instruction.....	6
5. Data Report.....	7
5.1 Example of ReportDataCmd.....	8
5.2 Example of ConfigureCmd.....	10
5.3 Example of Set/GetSensorAlarmThresholdCmd.....	11
5.4 Example of NetvoxLoRaWANRejoin.....	12
5.5 Example for MinTime/MaxTime logic.....	14
6. Installation.....	16
7. Information about Battery Passivation.....	18
7.1 To determine whether a battery requires activation.....	18
7.2 How to activate the battery.....	18
8. Important Maintenance Instruction.....	19

1. Introduction

The R718N1xxx(E) series is the single-phase current meter device for Netvox Class A type devices based on the LoRaWAN open protocol and is compatible with the LoRaWAN protocol. R718N1xxx(E) series has different measuring range for different variety of CT. It is divided into:

Model	Name	CT cables
R718N17	Wireless Single-Phase Current Meter with 1 x 75A Clamp-On CT	-
R718N17E		Detachable cables
R718N115	Wireless Single-Phase Current Meter with 1 x 150A Clamp-On CT	-
R718N115E		Detachable cables
R718N125	Wireless Single-Phase Current Meter with 1 x 250A Clamp-On CT	-
R718N125E		Detachable cables
R718N163	Wireless Single-Phase Current Meter with 1 x 630A Clamp-On CT	-
R718N163E		Detachable cables
R718N1100	Wireless Single-Phase Current Meter with 1 x 1000A Clamp-On CT	-
R718N1100E		Detachable cables
R718N1300	Wireless Single-Phase Current Meter with 1 x 3000A Clamp-On CT	-

LoRa Wireless Technology

LoRa is a wireless communication technology famous for its long-distance transmission and low power consumption. Compared with other communication methods, LoRa spread spectrum modulation technique greatly extend the communication distance. It can be widely used in any use case that requires long-distance and low-data wireless communications. For example, automatic meter reading, building automation equipment, wireless security systems, industrial monitoring. It has features like small size, low power consumption, long transmission distance, strong anti-interference ability and so on.

LoRaWAN

LoRaWAN uses LoRa technology to define end-to-end standard specifications to ensure interoperability between devices and gateways from different manufacturers.

2. Appearance



R718N17 (Non-detachable cable)

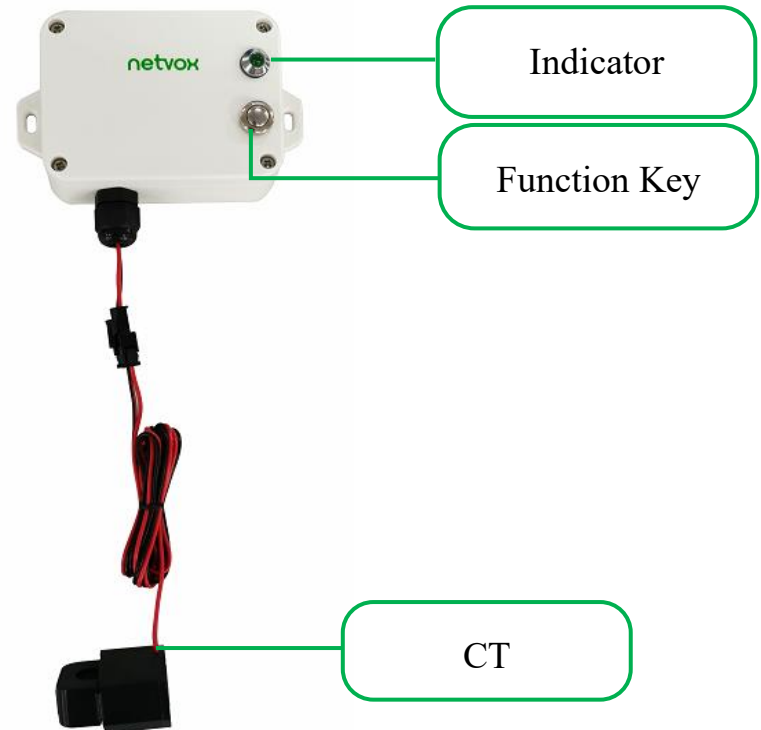

R718N17E (Detachable cable)



R718N115 (Non-detachable cable)



R718N115E (Detachable cable)



R718N125 (Non-detachable cable)



R718N125E (Detachable cable)



R718N163 (Non-detachable cable)



R718N163E (Detachable cable)



R718N1100 (Non-detachable cable)



R718N1100E (Detachable cable)



R718N1300 (Non-detachable cable)

3. Features

- 2 x ER14505 lithium battery in parallel (3.6V/section)
- Only support AC current measuring.
- Main body: IP53; Current transformer: IP30
- LoRaWAN™ Class A compatible
- Frequency Hopping Spread Spectrum (FHSS)
- Available third-party platform: Actility/ThingPark, TTN, MyDevices/Cayenne
- Low power consumption and long battery life

Note:

Please visit http://www.netvox.com.tw/electric/electric_calc.html for detailed information about battery life calculation.

1. The actual range may vary depending on the environment.
2. Battery life is determined by sensor reporting frequency and other variables.

4. Set up Instruction

On/Off

Power on	Insert batteries. (Users may need a screwdriver to open the battery cover.)
Turn on	Press and hold the function key for 3 seconds until the green indicator flashes once.
Turn off (Reset to factory setting)	Press and hold the function key for 5 seconds until the green indicator flashes 20 times.
Power off	Remove Batteries.
<p>Note: 1. The device will be off by default after removing the battery and inserting it again.</p> <p>2. Please wait for 10 seconds between turning on and off the device.</p> <p>3. 5 seconds after power on, the device will be in engineering test mode.</p>	

Network Joining

Never joined the network	<p><u>Turn on the device and search for the network to join.</u></p> <p>The green indicator light stays on for 5 seconds: Success</p> <p>The green indicator light remains off: Fail</p>
Had joined the network (without factory resetting)	<p><u>Turn on the device, and it will search for the previous network to join.</u></p> <p>The green indicator light stays on for 5 seconds: Success</p> <p>The green indicator light remains off: Fail</p>
Fail to Join the Network	<p>1st – 2nd minutes: Wake up every 15 seconds to send a request for joining the network</p> <p>After 2nd minute: The device is in sleeping mode and wakes up every 15 minutes to send a request for joining the network</p>

Function Key

Press the function key and hold for 5 seconds	<p><u>The device will be set to default and turned off</u></p> <p>The green indicator light flashes 20 times: Success</p> <p>The green indicator light remains off: Fail</p>
Short press the function key (release it within 500ms)	<p>The device is in the network: the green indicator light flashes once and sends a report after sampling. (Note: Date sampling takes 15 seconds.)</p> <p>The device is not in the network: the green indicator light remains off</p>

Sleeping Mode

The device is turned on and in the network	<p>Sleep period: Min Interval.</p> <p>When the reportchange exceeds the setting value or the state changes, the device sends a data report based on the Min Interval.</p>
The device is turned on but not in the network	<p>1st – 2nd minutes: wake up every 15 seconds to send a request for joining the network</p> <p>After 2nd minute: The device is in sleeping mode and wakes up every 15 minutes to send a request for joining the network</p>

Low Voltage Warning

Low Voltage	3.2V
-------------	------

Note: a. To save energy, please remove the batteries when the device is not in use.

b. Please check the device verification information on the gateway or consult your platform server provider.

5. Data Report

The device will immediately send a version packet report along with two uplink packets including current value (mA).

The device sends data in the default configuration before any configuration is done.

Default setting:

Max Interval = 0x0708 (1800s) // MinTime cannot be less than 30 seconds. MaxTime must be greater than MinTime.

Min Interval = 0x0708 (1800s)

ReportChange= 0x0064 (100 mA)

Note:

(1) Min Interval < 30s → Data reported every 30 seconds

(2) Max Interval < Min Interval → Data reported at Min Interval

(3) Frequent changes of current may cause inaccurate results when the device is sampling (15 seconds before the beginning of the Min Interval).

Measurement Range and Accuracy:

Device	CT	Measurement Range	Accuracy
R718N17(E)	Clamp-on	100mA – 75A	±1%
R718N115(E)		1A – 150A	
R718N125(E)		1A – 250A	
R718N163(E)		5A – 630A	
R718N1100(E)		10A – 1000A	
R718N1300		150A – 3000A	

Note: (1) R718N1(E) and R718N17(E): report data as 0A when the current < 0.1A.

(2) R718N115(E), R718N125(E), R718N163(E), R718N1100(E), and R718N1300:
report data as 0A when the current < 1A.

Please refer Netvox LoRaWAN Application Command document and Netvox Lora Command Resolver

<http://www.netvox.com.cn:8888/cmddoc> to resolve uplink data.

Data report configuration and sending period are as follows:

Min. Interval (Unit: second)	Max. Interval (Unit: second)	Reportable Change	Current Change ≥ Reportable Change	Current Change < Reportable Change
Any number between 30 to 65535	Any number between Min Interval to 65535	Can not be 0	Report per Min. Interval	Report per Max. Interval

5.1 Example of ReportDataCmd

FPort: 0x06

Bytes	1	1	1	Var (Fix = 8 Bytes)
	Version	DeviceType	ReportType	NetvoxPayLoadData

Version– 1 byte –0x01—the Version of NetvoxLoRaWAN Application Command Version

DeviceType– 1 byte – Device Type of Device

ReportType – 1 byte –the presentation of the NetvoxPayLoadData, according the devicetype

NetvoxPayLoadData– Fixed bytes (Fixed = 8 bytes)

Tips

1. Battery Voltage:

The voltage value is bit 0 ~ bit 6, bit 7=0 is normal voltage, and bit 7=1 is low voltage.

Battery=0xA0, binary=1010 0000, if bit 7= 1, it means low voltage.

The actual voltage is 0010 0000 = 0x20 = 32, 32*0.1v =3.2v

2. Version Packet:

When Report Type=0x00 is the version packet, such as 0149000A02202208210000, the firmware version is 2022.08.21.

3. Data Packet:

When Report Type=0x01 is data packet.

4. Current Value:

The maximum payload of Current is 2 bytes, which means the maximum value that can be shown is 65535mA. To get the actual current value, the current needs to time Multiplier as it exceeds 65535mA.

Device	Device Type	Report Type	NetvoxPayloadData				
R718N1xxx(E) Series	0x49	0x00	SoftwareVersion (1 Byte) Eg.0x0A-V1.0	HardwareVersion (1 Byte)	DateCode (4 Bytes) eg 0x20170503	Reserved (2 Bytes)	
		0x01	Battery (1 Byte, unit:0.1v)	Current (2 Bytes, unit: mA)	Multiplier (1 Byte)	ThresholdAlarm (1Byte) Bit0_LowCurrentAlarm Bit1_HighCurrentAlarm Bit2-7:Reserved	Reserved (3 Bytes)

(1) Example 1 of Uplink: 014901240E150100000000

1st byte (01): Version

2nd byte (49): DeviceType – R718N1xxx(E) Series

3rd byte (01): ReportType

4th byte (24): Battery – 3.6V 24 (Hex) = 36 (Dec), 36* 0.1v = 3.6v

5th – 6th byte (0E15): Current – 3605 mA 0E15 (Hex) = 3605 (Dec), 3605* 1mA = 3605mA

7th byte (01): Multiplier – 1

8th byte (00): Threshold Alarm – No alarm

9th-11th byte (000000): Reserved

(2) Example 2 of Uplink: 014901A01B580A02000000

1st byte (01): Version

2nd byte (49): DeviceType – R718N1xxx(E) Series

3rd byte (01): ReportType

4th byte (A0): Battery – 3.2V A0 (Hex) = 1010 0000(Bin), bit7=1 means low voltage, 20(Hex)=32(Dec), 32* 0.1v = 3.2v

5th – 6th byte (1B58): Current – 7000 mA 1B58 (Hex) = 7000 (Dec), 7000mA*10 = 70000mA(70A)

7th byte (0A): Multiplier – 10

8th byte (02): Threshold Alarm – HighCurrentAlarm, 02(Hex)=0000 00010(Bin), bit1=1 HighCurrentAlarm

9th-11th byte (000000): Reserved

5.2 Example of ConfigureCmd

FPort: 0x07

Bytes	1	1	Var (Fix = 9 Bytes)
	CmdID	DeviceType	NetvoxPayloadData

CmdID– 1 byte

DeviceType– 1 byte – Device Type of Device

NetvoxPayloadData– var bytes (Max = 9bytes)

Description	Device	Cmd ID	Device Type	NetvoxPayloadData			
Config ReportReq	R718N1xxx(E) Series	0x01	0x49	MinTime (2bytes Unit:s)	MaxTime (2bytes Unit: s)	CurrentChange (2byte Unit:1mA)	Reserved (3Bytes, Fixed 0x00)
Config ReportRsp		0x81		Status (0x00_success)		Reserved (8Bytes,Fixed 0x00)	
ReadConfig ReportReq		0x02		Reserved (9Bytes,Fixed 0x00)			
ReadConfig ReportRsp		0x82		MinTime (2bytes Unit:s)	MaxTime (2bytes Unit: s)	CurrentChange (2byte Unit:1mA)	Reserved (3Bytes, Fixed 0x00)

(1) Configure device parameters

MinTime = 60s (0x003C), MaxTime = 60s (0x003C), CurrentChange = 100mA (0x0064)

Downlink: 0149003C003C0064000000

The device returns:

81490000000000000000000 (Configuration successful)

81491000000000000000000 (Configuration failed)

(2) Read device configuration parameter

Downlink: 0249000000000000000000

The device returns:

8249003C003C0064000000 (Current device configuration parameters)

5.3 Example of Set/GetSensorAlarmThresholdCmd

Fport: 0x10

CmdDescriptor	CmdID (1Byte)	Payload (10Bytes)			
SetSensorAlarm ThresholdReq	0x01	Channel(1Byte) 0x00_Channel 1	SensorType(1Byte) 0x00_Disable ALL 0x27_Current	SensorHighThreshold (4Bytes,Unit:1mA)	SensorLowThreshold (4Bytes,Unit:1mA)
SetSensorAlarm ThresholdRsp	0x81	Status (0x00_success)		Reserved (9Bytes,Fixed 0x00)	
GetSensorAlarm ThresholdReq	0x02	Channel (1Byte, 0x00_Channel1)	SensorType(1Byte) 0x00_Disable ALL 0x27_Current	Reserved (8Bytes,Fixed 0x00)	
GetSensorAlarm ThresholdRsp	0x82	Channel (1Byte) 0x00_Channel 1	SensorType(1Byte) 0x00_Disable ALL 0x27_Current	SensorHighThreshold (4Bytes,Unit:1mA)	SensorLowThreshold (4Bytes,Unit:1mA)

Note:

- a. Set SensorHigh/LowThreshold as 0xFFFFFFFF to disable threshold.
- b. The last configuration would be kept as user reset the device back to the factory setting.
- c. Firmware after 2023.07.24 supports threshold alarm.

(1) Configure device parameter

Channel = 0x00 (fixed value), SensorType = 0x27 (fixed value), SensorHighThreshold = 1000mA (0x000003E8),

SensorLowThreshold=100mA (0x00000064)

Downlink: 010027000003E800000064

The device returns:

810000000000000000000000 (Configuration successful)

810100000000000000000000 (Configuration failed)

(2) Read device configuration parameters.

Downlink: 0200270000000000000000

The device returns:

820027000003E800000064 (Current device configuration parameters)

5.4 Example of NetvoxLoRaWANRejoin

Check if the device is still in the network. If the device is disconnected, it will automatically rejoin back to the network.

Fport: 0x20

CmdDescriptor	CmdID (1 byte)	Payload						
SetNetvoxLoRaWAN RejoinReq	0x01	RejoinCheckPeriod(4 Bytes, Unit: 1s)				RejoinThreshold(1 Byte)		
SetNetvoxLoRaWAN RejoinRsp	0x81	Status (1 Byte, 0x00_success)				Reserved (4 Bytes, Fixed 0x00)		
GetNetvoxLoRaWAN RejoinReq	0x02	Reserved (5 Bytes, Fixed 0x00)						
GetNetvoxLoRaWAN RejoinRsp	0x82	RejoinCheckPeriod (4 Bytes, Unit: 1s)				RejoinThreshold (1Byte)		
SetNetvoxLoRaWAN RejoinTimeReq	0x03	1st Rejoin Time (2 Bytes, Unit: 1Min)	2nd Rejoin Time (2 Bytes, Unit: 1Min)	3rdRejoin Time (2 Bytes, Unit: Min)	4th Rejoin Time (2 Bytes, Unit: Min)	5th Rejoin Time (2 Bytes, Unit: Min)	6th Rejoin Time (2 Bytes, Unit: Min)	7th Rejoin Time (2 Bytes, Unit: Min)
SetNetvoxLoRaWAN RejoinTimeRsp	0x83	Status (1 Byte, 0x00_success)				Reserved (13 Bytes, Fixed 0x00)		
GetNetvoxLoRaWAN RejoinTimeReq	0x04	Reserved (15 Bytes, Fixed 0x00)						
GetNetvoxLoRaWAN RejoinTimeRsp	0x84	1st Rejoin Time (2 Bytes, Unit: 1Min)	2nd Rejoin Time (2 Bytes, Unit: 1Min)	3rdRejoin Time (2 Bytes, Unit: Min)	4th Rejoin Time (2 Bytes, Unit: Min)	5th Rejoin Time (2 Bytes, Unit: Min)	6th Rejoin Time (2 Bytes, Unit: Min)	7th Rejoin Time (2 Bytes, Unit: Min)

Note:

- Set RejoinCheckThreshold as 0xFFFFFFFF to stop the device from rejoining the network.
- The last configuration would be kept as user reset the device back to the factory setting.
- Default setting: RejoinCheckPeriod = 2 (hr) and RejoinThreshold = 3 (times)

1st Rejoin Time = 0x0001 (1 min), 2nd Rejoin Time = 0x0002 (2 mins), 3rd Rejoin Time = 0x0003 (3 mins),
4th Rejoin Time = 0x0004 (4 mins), 5th Rejoin Time = 0x003C (60 mins), 6th Rejoin Time = 0x0168 (360
mins), 7th Rejoin Time = 0x05A0 (1440 mins)

(1) Command Configuration

Set RejoinCheckPeriod = 3600s (0x00000E10), RejoinThreshold = 3 times

Downlink: 0100000E1003

Response:

810000000000 (Configuration success)

810100000000 (Configuration failure)

(2) Read current configuration

RejoinCheckPeriod, RejoinThreshold

Downlink: 020000000000

Response: 8200000E1003

(3) Configure Rejoin Time

1st Rejoin Time = 0x0001 (1 min), 2nd Rejoin Time = 0x0002 (2 mins), 3rd Rejoin Time = 0x0003 (3 mins),

4th Rejoin Time = 0x0004 (4 mins), 5th Rejoin Time = 0x0005 (5 mins), 6th Rejoin Time = 0x0006 (6 mins),

7th Rejoin Time = 0x0007 (7 mins)

Downlink: 030001000200030004000500060007

Response: 83000000000000000000000000000000 (Configuration success)

83010000000000000000000000000000 (Configuration failure)

(4) Read Rejoin Time parameter

Downlink: 04000000000000000000000000000000

Response: 840001000200030004000500060007

5.5 Example for MinTime/MaxTime logic

Example#1 based on MinTime = 1 Hour, MaxTime= 1 Hour, Reportable Change i.e. BatteryVoltageChange=0.1V

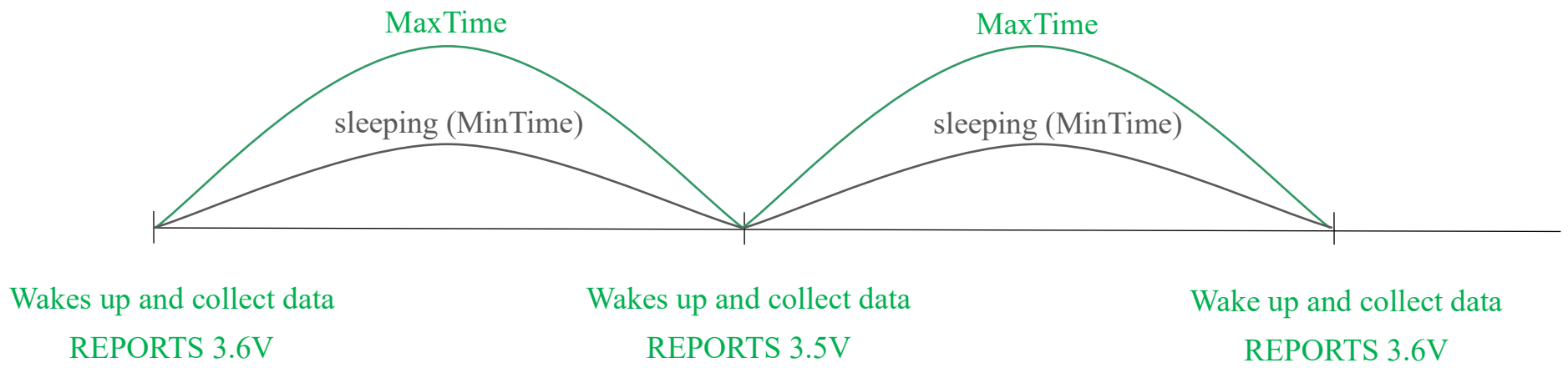

Note: MaxTime = MinTime. Data will only be reported according to MaxTime (MinTime) duration regardless BatteryVoltageChange value.

Example#2 based on MinTime = 15 Minutes, MaxTime= 1 Hour, Reportable Change i.e. BatteryVoltageChange= 0.1V.

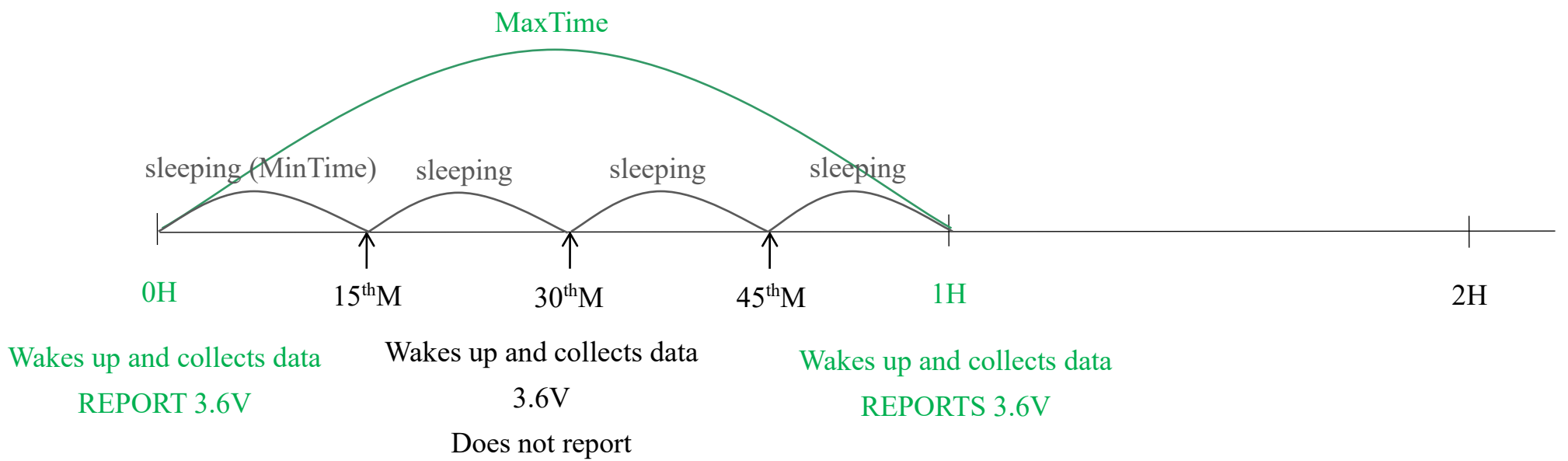

Example#3 based on MinTime = 15 Minutes, MaxTime= 1 Hour, Reportable Change i.e. BatteryVoltageChange= 0.1V.

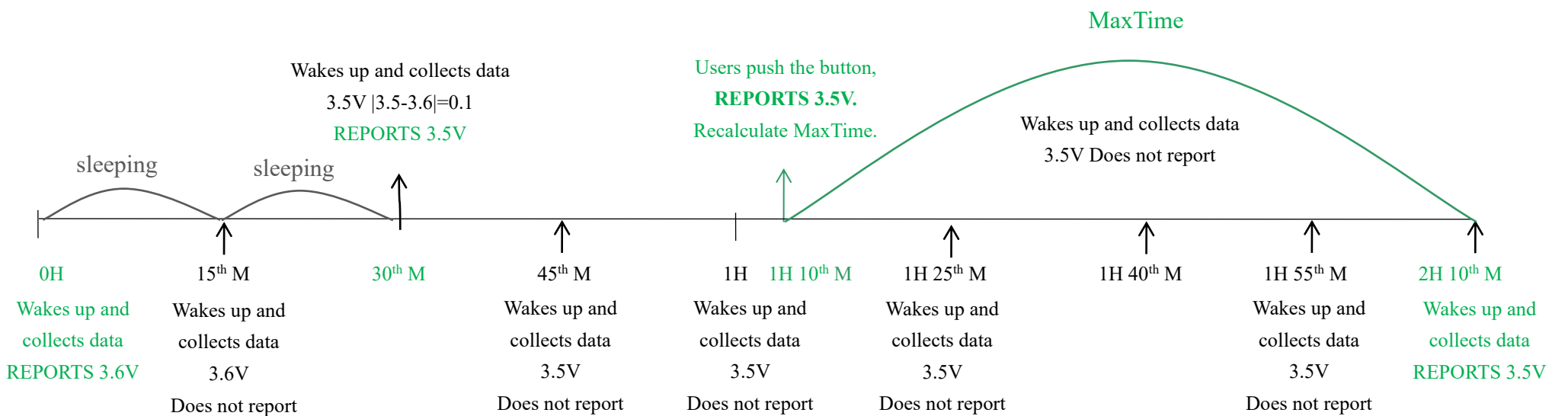

Notes :

- 1) The device only wakes up and performs data sampling according to MinTime Interval. When it is sleeping, it does not collect data.
- 2) The data collected is compared with the last data reported. If the data variation is greater than the ReportableChange value, the device reports according to MinTime interval. If the data variation is not greater than the last data reported, the device reports according to MaxTime interval.
- 3) We do not recommend to set the MinTime Interval value too low. If the MinTime Interval is too low, the device wakes up frequently and the battery will be drained soon.
- 4) Whenever the device sends a report, no matter resulting from data variation, button pushed or MaxTime interval, another cycle of MinTime/MaxTime calculation is started.

6. Installation

1. The single-phase current meter R718N1xxx(E) series has a built-in magnet (see Figure 1 below). It can be attached to the surface of an object with iron during installation, which is convenient and quick.

To make the installation more secure, please use screws (purchased separately) to fix the device to the wall or other objects (such as the installation diagram).

Note: Do not install the device in a metal-shielded box or in an environment surrounded by other electrical equipment to avoid affecting the wireless transmission of the device.

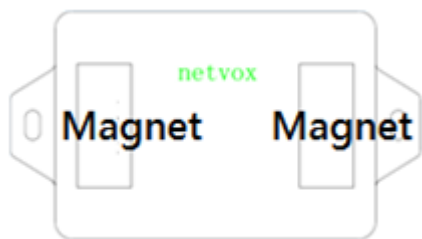

2. Open the clamp-on current transformer, and then pass the live wire through the current transformer according to the installation.

Note: "L←K" is marked on the bottom of the CT.

3. Precautions:

3.1 Before using, users must check whether the appearance is deformed; otherwise, the test accuracy will be affected.

3.2 The using environment should be kept away from strong magnetic fields, so as not to affect the test accuracy. It is strictly forbidden to use in humid and corrosive gas environments.

3.3 Before installation, please confirm the current value of the load. If the current value of the load is higher than the measurement range, select a model with a higher measurement range.

4. The single-phase current meter samples the current according to MinTime. If the current value sampled this time relatively exceeds the set value (the default is 100mA) more than the current value reported last time, the device will immediately report the current value sampled this time. If the current variation does not exceed the default value, the data will be reported regularly according to MaxTime.

5. Press the function key of the device to start sampling data and report the data after 15 seconds.

Note: MinTime cannot be less than 30 seconds.

MaxTime must be set greater than Min Time.

The single-phase current detector R718N1xxx(E) is suitable for the following scenarios:

- School
- Factory
- Shopping mall
- Office building
- Smart building

Where the electrical data of the device with the single-phase electricity needs to be detected.

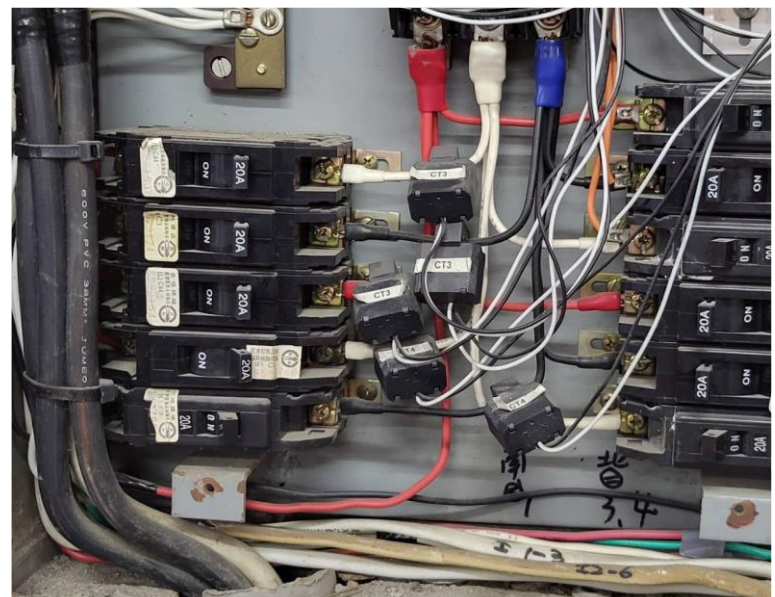

1. The back of R718N1xxx(E) can be attached to iron surface or users can fix the two ends of device on the wall with screws.
2. When installing the R718N1xxx(E) series current transformer, please separate the live and neutral wires of the wire to be detected, and only take the live wire through current transformer and start the measurement according to the wiring below:

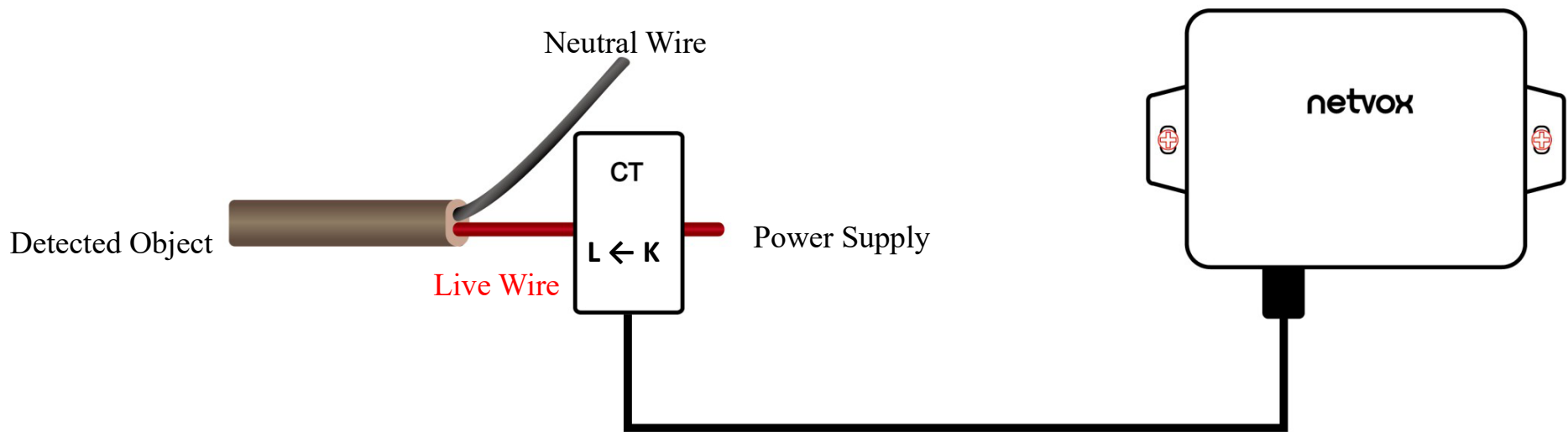

CT Wiring Schematic Diagram (Current direction K→L)

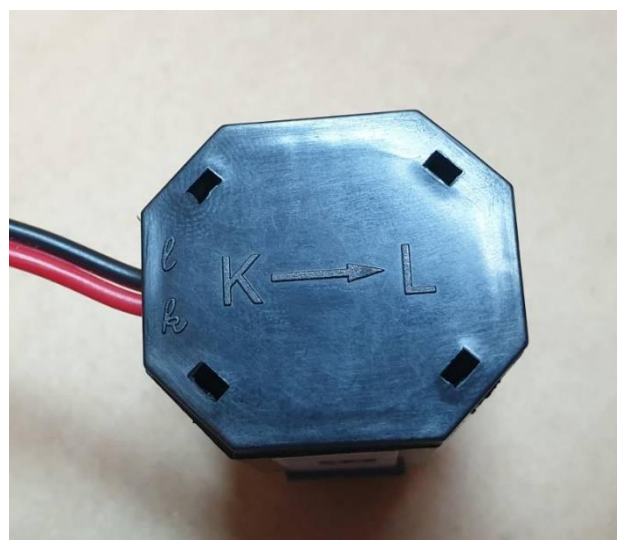

If the live wire and the neutral wire are connected together at the same time, they will offset each other and the measurement is 0.

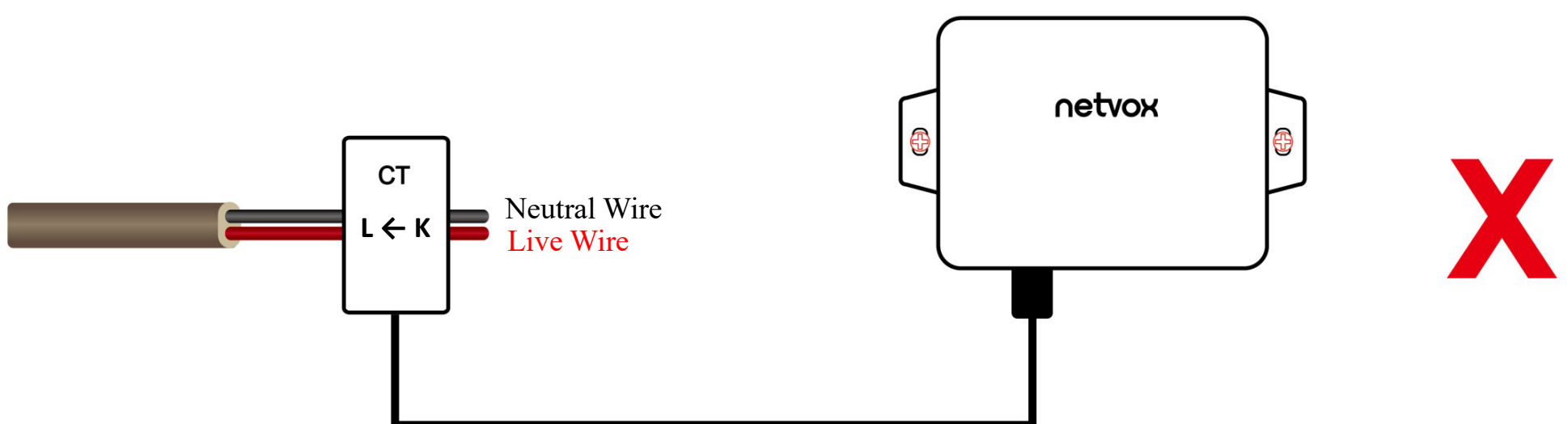

Note:

1. Please do not disassemble the device unless it is required to replace the batteries.
2. Do not touch the waterproof gasket, LED indicator, and function keys when replacing the batteries. Please use suitable screwdriver to tighten the screws (if using an electric screwdriver, it is recommended to set the torque as 4kgf) to ensure the device is impermeable.

7. Information about Battery Passivation

Many of Netvox devices are powered by 3.6V ER14505 Li-SOCl₂ (lithium-thionyl chloride) batteries that offer many advantages including low self-discharge rate and high energy density. However, primary lithium batteries like Li-SOCl₂ batteries will form a passivation layer as a reaction between the lithium anode and thionyl chloride if they are in storage for a long time or if the storage temperature is too high. This lithium chloride layer prevents rapid self-discharge caused by continuous reaction between lithium and thionyl chloride, but battery passivation may also lead to voltage delay when the batteries are put into operation, and our devices may not work correctly in this situation.

As a result, please make sure to source batteries from reliable vendors, and it is suggested that if the storage period is more than one month from the date of battery production, all the batteries should be activated. If encountering the situation of battery passivation, users can activate the battery to eliminate the battery hysteresis.

ER14505 Battery Passivation

7.1 To determine whether a battery requires activation

Connect a new ER14505 battery to a resistor in parallel, and check the voltage of the circuit.

If the voltage is below 3.3V, it means the battery requires activation.

7.2 How to activate the battery

- a. Connect a battery to a resistor in parallel
- b. Keep the connection for 5~8 minutes
- c. The voltage of the circuit should be ≥ 3.3 , indicating successful activation.

Brand	Load Resistance	Activation Time	Activation Current
NHTONE	165 Ω	5 minutes	20mA
RAMWAY	67 Ω	8 minutes	50mA
EVE	67 Ω	8 minutes	50mA
SAFT	67 Ω	8 minutes	50mA

Note:

If you buy batteries from other than the above four manufacturers, then the battery activation time, activation current, and required load resistance shall be mainly subject to the announcement of each manufacturer.

8. Important Maintenance Instruction

Kindly pay attention to the following in order to achieve the best maintenance of the product:

- Do not put the device near or submerge into water. Minerals in rain, moisture, and other liquids could cause corrosion of electronic components. Please dry the device, if it gets wet.
- Do not use or store the device in dusty or dirty environments to prevent damage to parts and electronic components.
- Do not store the device in high temperatures. This may shorten the lifespan of electronic components, damage batteries, and deform plastic parts.
- Do not store the device in cold temperatures. Moisture may damage circuit boards as the temperatures rise.
- Do not throw or cause other unnecessary shocks to the device. This may damage internal circuits and delicate components.
- Do not clean the device with strong chemicals, detergents, or strong detergents.
- Do not apply the device with paint. This may block detachable parts and cause malfunction.
- Do not dispose of batteries in fire to prevent explosion.

The instructions are applied to your device, battery, and accessories.

If any device is not working properly, please bring it to the nearest authorized service provider for repair.